

RotoBed®

Rotate Life Better



Your home – your life!

DIGNITY, MOBILITY & FREEDOM



Registered NDIS provider



RotoBed® aims to deliver the world's most helpful beds. A RotoBed® offers less pain, longer mobility, more dignity, and an increased quality of life.

With a user weight up to 190 kg, and with the possibility of extra low bed height down to 32 cm, our beds are suitable for both overweight as well as tall or small users.

With a rotating RotoBed®, it takes less than one minute and just a push on a single button to go from lying to standing up. We call that good welfare technology.





Hans Sandgren Jakobsen

RotoBed® has won several design awards, including the prestigious IF Design Award and the European Product Design Award.

The harmonic design is created by Danish furniture designer Hans Sandgren Jakobsen. Overlooking the sea and sky from his studio at Grenaa Harbor, Hans Sandgren Jakobsen works on the basis of Scandinavian design.

Innovation, aesthetics and functionality are the three key words that Hans Sandgren Jakobsen himself emphasizes most during his design process.

This fully agrees with RotoBed® and our desire to provide care beds that increase the user's quality of life and at the same time appear like homely furniture.

Hans Sandgren Jakobsen has received numerous awards and prizes for his work, including the Red Dot Design Award, IF Design Award Gold, the Formland Prize and and most recently, for RotoBed® the IF Design Award 2019, the European Product Design Award 2020 and the SIT Furniture Award 2020.





RotoBed® Change with fully automatic rotation



With a RotoBed®, people who have difficulty getting in and out of bed are now able to do so with no physical effort.

Just by a single touch of a remote control the bed is elevated to chair position and rotated towards the room.

This facilitates both exit and transition to a wheelchair or stand-aid.

Simple and comprehensive remote control.

Besides the rotating function also height, backrest and leg part are adjusted with the remote control.

The rotating mechanism is smooth, quiet and very comfortable for the user.

The patient surface is 4-sectioned and provides optimal support.

Several welfare technology surveys have shown that a RotoBed® enhances the user's level of self-reliance, mobility, and quality of life.

RotoBed®Classic...

RotoBed®Classic is a harmoniously designed functional bed with a built-in option to upgrade to a RotoBed®Change with rotation.

The RotoBed®Classic has electrical adjustment of backrest and leg-part to ensure comfortable positions in bed.

Furthermore, it has height adjustment. The bed base can be moved down to 32 cm above the

floor and up to 72 cm above the floor. This is very beneficial for people with pain or a limited mobility when getting in and out of bed.

If the user's needs change, the RotoBed®Classic can be upgraded with a rotational function, which turns it into a RotoBed®Change.



...and RotoBed®Change – *A beautiful couple*

When one part of a couple has physical challenges, a functional bed can be crucial to maintain mobility. However, most couples wish to sleep next to each other in similar beds. In these cases, a combination of a RotoBed®Classic and a RotoBed®Change is the perfect solution.

The beds have the same beautiful design, and both have height adjustment as well as adjustable

backrest, leg part and foot part. On top of this, RotoBed®Change has also the rotational function – and should the partner's needs change, the RotoBed®Classic can be upgraded to a bed with rotation too.



RotoBed® Testimonials



My wife has less pain and more dignity

Nadal Antonioni, Florida, USA. His wife Dora is partially paralyzed after several operations and a spinal fusion.

Dora used to have a simple hospital bed and we struggled to move her out of the bed for meals, toilet visits and visits to doctors. We have two care givers, who are very capable on moving techniques, but it still required a lot of physical efforts and care to get her out of bed without hurting her. We could not find a bed that would solve these problems until, luckily, we found RotoBed® over the internet.

The rotational feature is unique; we did not find something similar in any bed, it is fantastic. It makes the task of helping my wife out of bed much easier and safer, and the care givers are very happy, since there is no need of physical effort. In addition, the ability for the bed to be moved up and down in height makes it much easier for the care givers to wash her and care for her.

My wife is now much more comfortable and can live a life with less pain and more dignity, and the care givers are happy. We have several health professionals coming to treat my wife they all say they never saw a bed like this, so elegant and well designed.



The RotoBed® made Hans self-reliant

Hans Villadsen, 77 years old, Solrød, Denmark. Suffers from PSP (atypical Parkinson's). His wife Else says:

Two years ago, it had become so difficult for Hans to control his movements that he often fell when he got out of bed. He could not lift his own legs out of bed, and it became too hard for me to help him by myself. He weighs almost twice as much as I do.

The municipality suggested a RotoBed®. We were not even aware that such a thing existed, but it sounded like a dream, and it really made a difference right from the start. Hans still needs to be guided a bit - e.g. I tell him to move his right foot forward a little - but apart from that he manages.

I cannot imagine Hans having to live a life being hoisted in and out of bed. Hanging up there, and... it is uncomfortable, unworthy. I want him to keep the mobility he has, after all, for as long as possible. He can do that with his RotoBed®.

It was a physical relief for me when we got the bed. But it has meant so much more to Hans. As an ambulance driver, he has helped other people all his life. Suddenly he was the weak one and that was hard for him. When he became self-reliant again with this RotoBed®, it turned back on the light in his eyes.



Now Joseph can go out for some fresh air

Josef Ribí, 89 years. Székesfehérvár, Hungary. Suffers from Parkinson's. His son Peter explains:

All his grown life, Josef Ribí has worked hard. He is strong and survived both cancer and a heart attack during his life. But 9 years ago, Josef was hit by Parkinson's, and gradually he is losing control of his movements. At the same time, it gets harder and harder for his wife to help as she also has poor health herself. It pains Josef's son Peter to watch his father become less and less self-reliant.

"It is a big change for him. He was always an active man, and now he was practically restricted to his flat", says Peter Ribí. Two years ago, it had become almost impossible for Josef to get out of bed. By coincidence Peter saw a Facebook video presenting RotoBed®.

"I could see this bed could be a great help for my parents, and my father was open to try it."

Today, the RotoBed® helps Josef in and out of bed every day and allows him to spend his energy on the trips to the small courtyard and the birds in it. Peter Ribí does not regret spending money on a RotoBed®.

- Without this bed it would be almost impossible for my father to get out of bed. He is so happy about it and very often tells me how grateful he is that I got him a RotoBed®.

This bed is fantastic.

RotoBed®Home

RotoBed®Home is a harmoniously designed piece of furniture. You can customize your bed according to your own desires in terms of exit height, colours and head- and footboard designs.



Exit height

RotoBed®Home is suitable for both tall and small users. By measuring your leg length from flat foot to the hollow of the knee, you will find the one of the four exit heights that best suits you. It is

possible to change the exit height afterwards by moving a few screws. The bed is also equipped with adjusting screws for fine tuning the exit height.



15.7-17 in



17.1-18.5 in



18.6-20 in



20.1-23.2 in

Colors

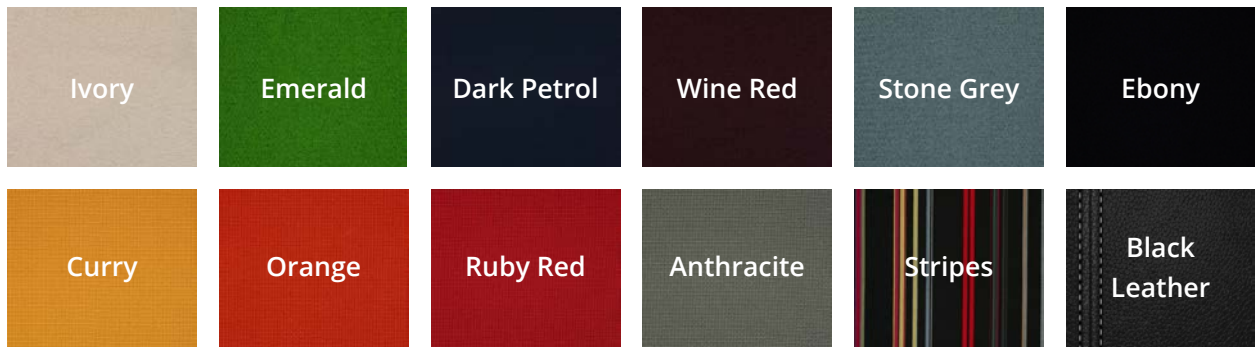

You can add your own touch to your RotoBed®Home by choosing from 10 different colors of the fabric that covers the headboards. The fabrics are produced by the Danish company Kvadrat, which works with sustainability and has achieved a wide range of environmental certificates in the EU and globally. RotoBed® has chosen two fabrics made from 51%

and 78% recycled plastic bottles respectively. Both have obtained UL Greenguard certification. The fabrics have a beautiful finish and are both durable and washable. In addition to the recycled textiles, it is also possible to choose the exclusive variant "Stripes" in pure wool designed by Paul Smith or black quality leather with white stitching.

Headboards and footboards



Low-Low



Low-High



High-High

RotoBed®Home head- and footboards are available in two variants: The low variant is made of moulded metal covered with removable textiles or leather.

The high variant is form bended oak veneer combined with fixed textiles or leather. You choose; the different combinations each give their own expression.

Simple and comprehensive remote control

Adjusting backrest, leg-part and position during rotation is very easy with the RotoBed® remote control.

User-friendliness is high, with only few and intelligible keys on the remote control. The two buttons "Chair Position" and "Sleeping Position" control the entire bed's rotation cycle.

It is also possible to store, using the remote control, your individual favorite settings for inclination of the backrest, as well as oblique or perpendicular exit.

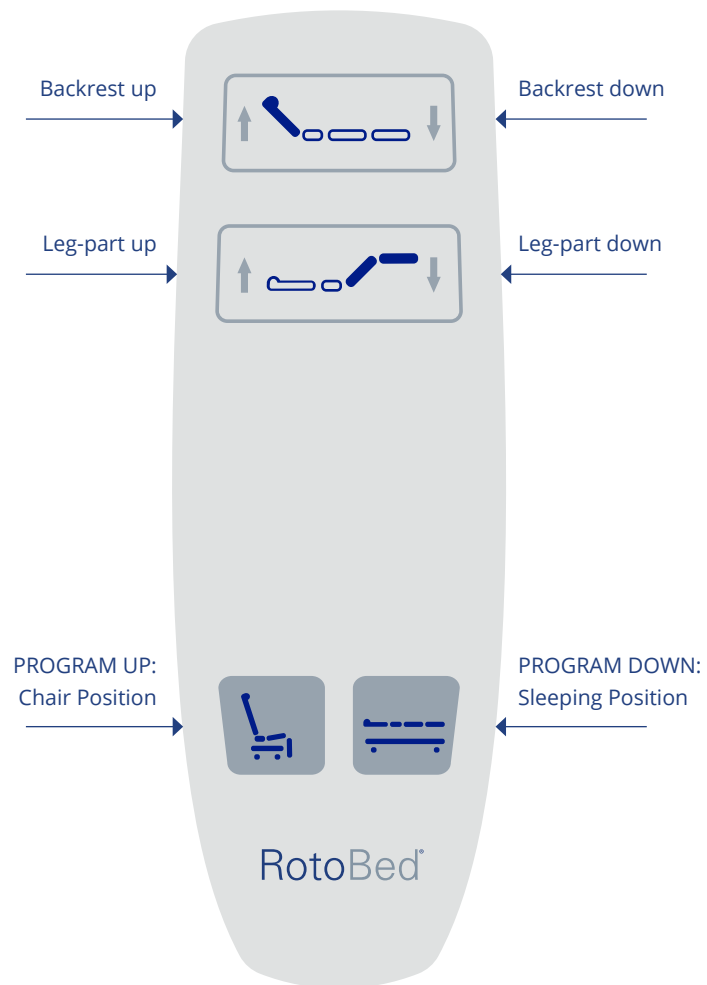

Wireless remote control in unique design

Exclusive and handy remote control. All buttons and functions can be operated with one hand, and navigation is simple and intuitive.

The display automatically adjusts the brightness to the surroundings. Time and date, flashlight and 6 optional languages.

The bed rotation cycle is controlled by holding a single key.

It is also possible to save individual favourite settings for backrest inclination as well as oblique or perpendicular exit.

Comes with specially designed leather case, attachable to the bedrail.



Welfare technology with care

In the park just outside our office, RotoBed® employees have views of both swans and breeding kingfishers. The beautiful animals daily remind us of our responsibility to protect the environment and nature.

RotoBed® strives to use long-lasting materials that are sustainable and reusable. Our fabrics come from the Danish company Kvadrat, which works

purposefully with sustainability and has achieved a large number of environmental certificates in the EU and globally. Kvadrat aims for CO₂ neutrality and conducts life cycle analysis for its products.

When our beds leave the production, it also happens on pallets and with packaging that is either recyclable or degradable.

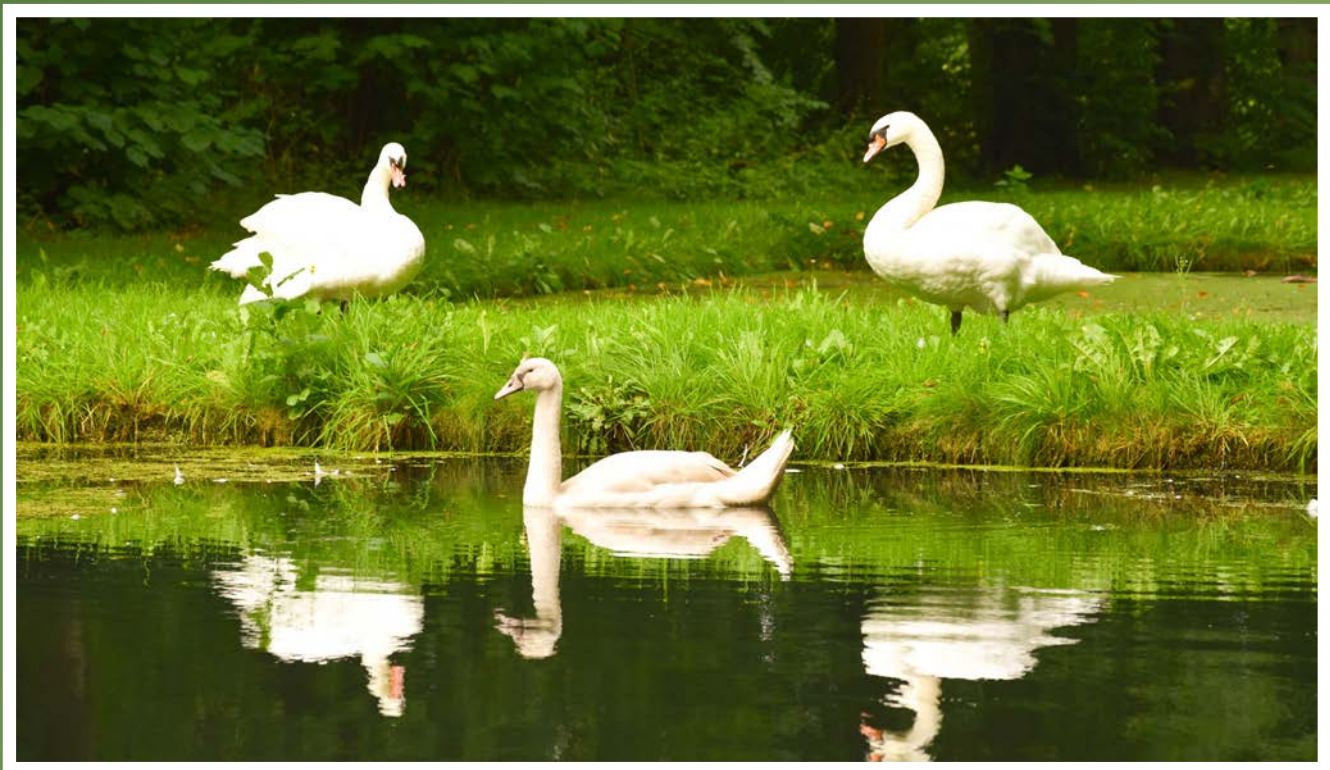

RotoBed® Light Package – a bright solution

With a new and patented invention, users of a RotoBed® can get out of bed safely also during night. When the RotoBed® rotates towards the floor, two soft spotlights under the bed will turn on – as well an external lamp after your choice. Maybe you want it to be the lamp in your bathroom?

When the bed is rotated back into sleeping position, both the spotlights and the lamp go out. This unique light system is developed in cooperation with LINAK. The external lamp is simply connected to the system by a plug.



Documented pressure ulcer prevention

RotoBed®SafeSleep – the luxury mattress

4-layer quality mattress combining comfort and optimal pressure distribution. RotoBed®SafeSleep offers prevention and treatment of pressure ulcers in stages 1-3. The 4 layers each have characteristics that increase flexibility and airflow, reducing the shear effect. Naturally produced without CFC and is CertiPur and OekoTex-100 certified.

Recommended user weight 40 kg - 120 kg.

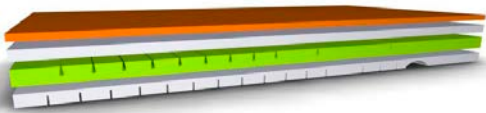

RotoBed®BariaSleep – the bariatric mattress

4-layer quality mattress with foam layers especially designed to distribute the body weight evenly to avoid pressure points and minimize horizontal shear.

Naturally produced without CFC and is CertiPur and OekoTex-100 certified.

Recommended user weight 120 kg – 190 kg.

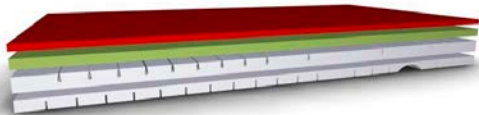

RotoBed® RoHo® - Decubitus protection mattress

2-layer quality mattress custom-made for RotoBed® with proven decubitus protection and treatment in all stages. The air cells are made from soft and flexible neoprene. The linked cells provide a large contact surface and a constant low pressure on both the skin and the deeper tissues. The mattress requires no use of an electrical pump. This makes transfer easier and saves user and staff of unpleasant noise, vibration, and heat.

Recommended user weight 40 kg – 190 kg.

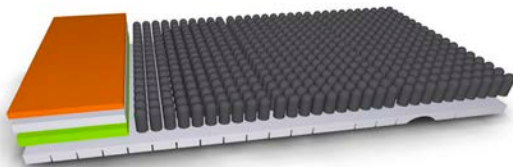



RotoBed®AirSleep - hybrid mattress

Decubitus, also known as pressure ulcers, can be very painful and require prolonged treatment and care. Pressure ulcers arise where the skin is close to the bones, for example on the back, hips and heel, and are caused by prolonged pressure against the skin and the tissues just below.

A healthy person changes position up to 30 times in one night, but unconscious, paralyzed or weakened people are unable to do so and will develop pressure ulcers if prevention is not initiated.

The best from 2 worlds

A hybrid mattress combines the pressure distribution properties of advanced foam mattresses with the periodic pressure relief as with alternating air mattresses.

Start by using RotoBed®AirSleep as a good pressure-distributing foam mattress with a high level of sleeping comfort. When the alternating function for periodic total relief of pressure against the skin is needed, just switch on the connected pump.

When the alternating function is no longer needed, simply disconnect the pump, and the mattress again works as a comfortable pressure-distributing mattress.

The ability to switch between static and dynamic function limits expensive and time-consuming mattress changes. This makes the hybrid systems particularly suitable for use in patient's homes, palliative care environments and hospital wards with patients at risk of pressure ulcers.

Protection and prevention of decubitus in all stages. Very quiet alternating system with a 5-year warranty. **User weight from 40 to 190 kg.**

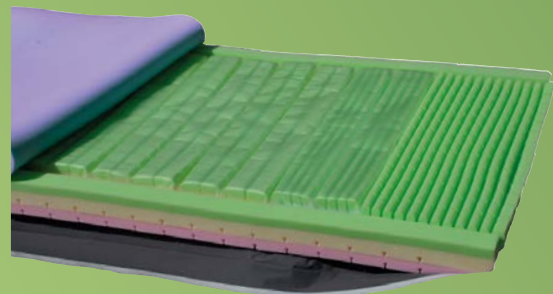

Technical info

Model	RotoBed®Change	RotoBed®Classic	RotoBed®Home
Height Adjustable	yes	yes	no
Height range:	32-72 cm above floor	32-72 cm above floor	40-59 cm above floor
Rotational function	yes	no	yes
User weight	135 kg	135 kg	190 kg
Mattress width	85 / 100 cm	85 / 100 cm	85 / 100 cm
Mattress length	205 / 215 / 225 cm	205 / 215 / 225 cm	205 / 215 / 225 cm
Weight indications			
Headboard	46 kg	46 kg	22 kg
Footboard	39 kg	39 kg	20 kg
Frame	80 kg	80 kg	104 kg
Total weight	165 kg	165 kg	146 kg
Requirements and standards	<p>All models are CE approved and meet the latest European standards and requirements according to directive 2006/42/EF and ISO EN 12100:2011.</p> <p>Motors and control box in top quality developed in cooperation with LINAK according to standard IPX6W</p>		

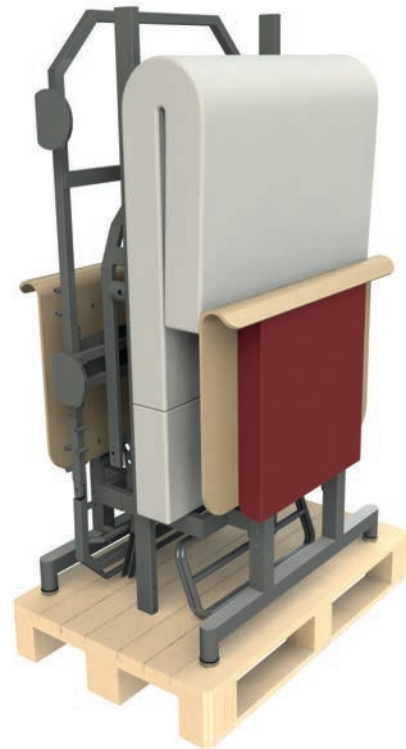
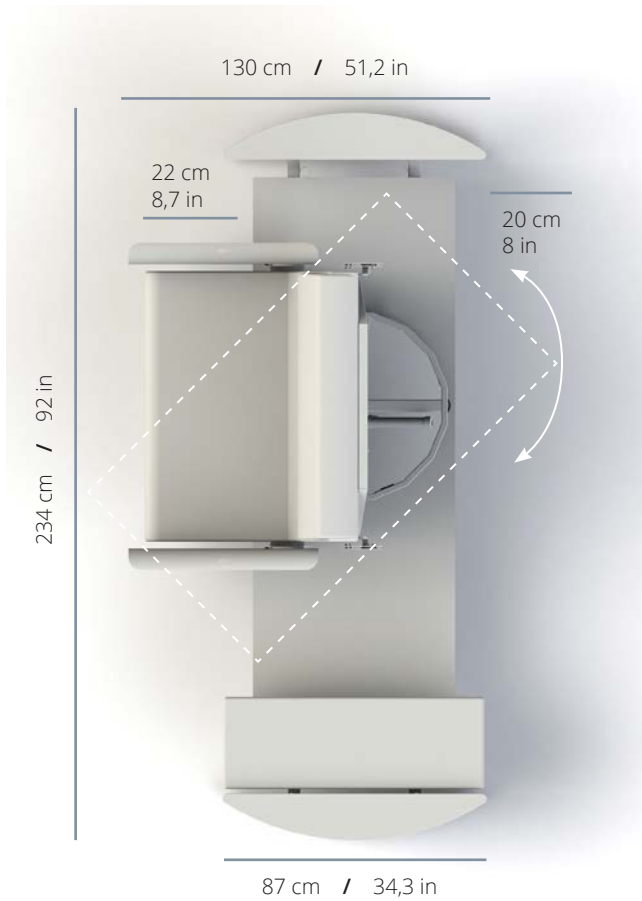

RotoBed® bed can be divided into three parts, which simplifies transportation and mounting.

Accessories



RotoBed®LED Lamp

Elegant lamp to be placed in the bed's built-in holders, in either right or left side of the bed.



RotoBed®Upholstery

Covers both bedrails. Material: Quality fabric from Danish Kvadrat, made of 100 % recycled plastic. Washable at 60°C.



RotoBed®Bedside Table

Oak veneer. Swiveling, mounted on either side of the bed. Diameter 30 cm. Inner height: 5 cm. Also available in black. Design: Hans Sandgren Jakobsen



RotoBed®Pillow

Pillow in thermos-elastic foam, width 80 cm.

RotoBed®Pillowcase

Made of soft cotton jersey, attachable at backrest. Washable at 60°C.



RotoBed®Underbed Light

Two soft spotlights will turn on whenever the RotoBed® is rotated towards exit position. When the bed is rotated back, lights will go out.



RotoBed®Light Package

When RotoBed®Home rotates, a soft light under the bed will turn on – as well as any external lamp you choose. When the bed is rotated back, lights go out. The external lamp is connected to the system by a plug.



RotoBed®Lifting Pole

Including handle with seat belt. To be placed in the bed's built-in holders, in either right or left side of the bed.



RotoBed®Sheets

Sheets made of soft cotton jersey. Set consisting of a sheet for both main mattress and foot mattress. Washable at 60°C. Also available in black.



RotoBed®Protection Cover

Mattress cover made of supple, stretchable foil. Semi-impermeable, washable at 60°C. The top can be zipped off separately for washing.



RotoBed®Bedrails, long, metal

Provide good support when getting in and out of bed.



RotoBed®Bedrails, long, oak veneer

Provide good support when getting in and out of bed. Also available in black.



RotoBed®Bedrails, short, metal

Provide good support in connection with transfers in bed.



RotoBed®Bedrails, short, oak veneer

Provide good support in connection with transfers in bed. Also available in black.



RotoBed®RotoSlide

A slide sheet designed for people with difficulty turning over in bed.



RotoBed®RotoTurn

Sliding and turning system with integrated locking function. Specially adapted to RotoBed® rotative beds.



RotoBed®Battery Backup

Lithium battery from LINAK. Covers approximately 10 x cycle without power.



RotoBed®Trolley

Enables manual elevation of the RotoBed® to vertical position. CE marked and approved by the Danish Technological Institute.



RotoBed®RotoLift®

Elevates RotoBed® to vertical position with no physical exertion. To be used in combination with RotoBed®Trolley. CE marked and approved by the Danish Technological Institute.

RotoBed®RotoSlide 2way

Sliding sheet facilitating sideways transfers in the bed. Slides in two directions. Use in combination with RotoBed®RotoSlide.



Contact us to learn more

RotoBed® delivers our unique rotating beds to large parts of the world.

We value high quality and service and we have extensive experience in tailoring welfare technology solutions for municipalities, institutions and individuals.

RotoBed® rotative beds are produced with a strong focus on sustainability and recyclable materials.

For an appointment or more information, please do not hesitate to contact us.

RotoBed®

Rotate Life Better

Distributed in Australia by:

HospEquip Pty Ltd:

WA: (08) 9456 1661 | **VIC:** (03) 9580 1055

SA: (08) 7225 8720 | **QLD:** (07) 3448 9243

NSW: 1300 467 737

www.hospequip.com.au



RotoBed® believes in the concept of healing design. Good design contributes to a higher quality of life, and our beds have won several acknowledged design awards.



Registered NDIS provider

www.hospequip.com.au